

Unit Cooler: CCEH304M4-AP.CR.AL-CB

Capacity calculated	8.48 Kw	Refrigerant (1)	R404A
Capacity request	8.48 Kw	Evaporation temp. (Mean)	-8.0 °C
Margin	0.0 %	Superheating	0 K
Air Flow	5518 m3/h	Condensing temp.	40.0 °C
Air temperature IN / HR	0.0 / 85 °C / %	Subcooler	0 K
Air temperature OUT / HR	-3.1 / 92 °C / %	Frost thickness	- mm
Altitude	0 m		

Fan motor data (AC)

Fan number	4 N°	Total power	280 Watt
Diameter	300 mm	Total current	1.20 A
Voltage-Phase-Frequency	230 - 1 - 50/60 Volt/N°/Hz	Noise pressure level/Dist. (2)	46/10 dB(A)/mt
Operating percentage	100 %	Noise power level	77 dB(A)
Fan rotation speed / MAX	1400 rpm	Air throw (approximate) (3)	11 mt
Power x 1 Fan / MAX	70 Watt	Available static pressure	- Pa
Current x 1 Fan (4)/ MAX	0.30 A	Energy efficiency class	A

Technical data

Casing	Aluminium Prepainted	Tube material	Cross-fin Copper
Surface	32 m2	Fins material	Aluminium
Volume	6 dm3	Headers dimensions In	16 (5) mm
Fin spacing	6.0 mm	Headers dimensions Out	22 (5) mm
Net weight / Gross weight (5)	52/74 Kg	Packaging dimensions	660/2260/H605 mm
Max. operating pressure	30 bar	PED classification (6)	Art.4, Par.3

Option

CB; Wiring on terminal box

Dimensional Drawing

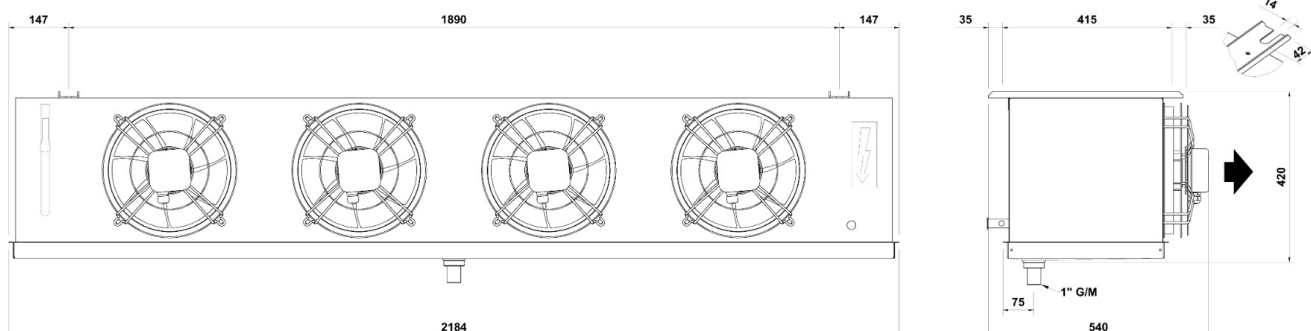

- 1) Fluid group according to pressure equipment directive 2014/68/EU
- 2) According to the enveloping surface method defined in EN 13487; tolerance = +2 dB(A).
- 3) Distance at which an air velocity of 0.25 m/s can still be measured isothermally in an ideal space. The achievable penetration depth of their flow in the cold room depends on the spatial geometry and other factors.
- 4) The current consumption can differ in dependence of the air temperature and of the variations of system voltage according to the VDE guidance.
- 5) Dimensions and weights are not valid for all possible options! They may differ for units with accessories or special units.
- 6) Final classification according to pressure equipment directive 2014/68/EU during order processing.
- 7) Safety regarding refrigerants use is regulated by EN378 and EN60335-2 standards and by safety data sheet of the fluid used. A2L flammable gases require a risk assessment by user, taking into account the characteristics of the system.
- 8) When ordering, it is necessary to indicate use of flammable refrigerants. The company reserves the right to modify the product and/or validate the order.