

# TEC C 030.A12-D3-80-S1N

## Air Cooler

### Heat Exchanger Technical Specifications

Model: TEC C 030.A12-D3-80-S1N

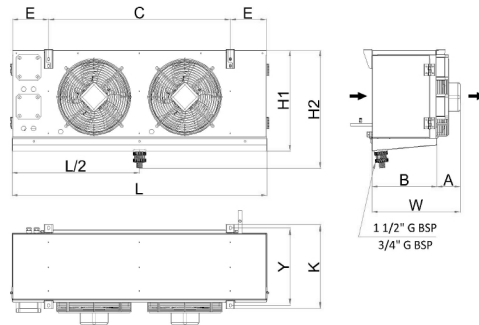

## Dimensions

<b>C :</b>	830 mm	<b>W :</b>	401 mm	<b>B :</b>	291 mm	<b>H2 :</b>	523 mm	<b>L :</b>	1182 mm
<b>H1 :</b>	448 mm	<b>F :</b>	0 mm	<b>E :</b>	176 mm	<b>B1 :</b>	0 mm	<b>A :</b>	111 mm
<b>K :</b>	370 mm	<b>Y :</b>	330 mm	<b>ØDin :</b>	1 x 12 [1/2"]	<b>ØDout :</b>	1 x 19 [3/4"]	<b>Wg :</b>	28 kg

## Evaporator Capacity Information

Capacity	2,191.18 Watt	Heat Transfer Area	6.70 m <sup>2</sup>
Average Room Temperature / Relative Humidity	-18.00 - 95 % / -19.43 °C - 97.31%	Tube Volume	2.01 dm <sup>3</sup>
Evaporation Temperature / ΔT	-25.00 °C / 7 K	Fin Spacing	8 mm
Superheating / Subcooling	4.5 K / 1 K	Test Pressure	40 bar
Condensation Temperature	40 °C	Max. Operating Pressure	26 bar
Refrigerant	R404A (Dew) (GPW: 3922)	Energy Efficiency Class (3)	A+
Fluid Flow / Pressure Drop	80.73 kg/h / 13.79 kPa	Pad Fluid Group	2
Altitude	0 m	Pad Category	Gas-I

## Evaporator Fan Information (ROSENBERG)

Airflow Rate / Air Velocity	3,509.55 m <sup>3</sup> /h / 3.17 m/s	Air Throw (Std./Strm.&Diff.) [Ref: 0,25 m/s]	11/19 m
Fan Diameter / Motor Type	Ø 300 mm / AC	Sound Power Level (LWA)	103 dBA
Number of Fans	2 Pcs	Sound Pressure Level (LPA)(2)	81 dBA
Total Fan Power	0.18 kW	Distance	3 m
Total Fan Current	0.76 A	Insulation Class	A
Voltage / Frequency / Phase	220 V / 50 Hz / 1 Phase	Protection Class	IP00
Fan Speed	1350 d/d	Temperature Range	60 °C

## Notes

- 1) Capacity Correction For Altitude is According To Engineering Calculations.
- 2) Sound Pressure Calculation Standard: En13487
- 3) Energy Efficiency Class Calculation Standards: En328 Standard. Standard Conditions: Sc2,R404A
- 4) TWATT product selection program is a Thermoway thermal device software. The data and images used belong to TWATT. The unauthorized use of data and images is prohibited. TWATT reserves the right to change all size and capacity values without prior notice.
- 5) For high pressure refrigerants such as R410A, please contact us to check maximum working pressure.