



WALL / CEILING AIR COOLER – PROFESSIONAL LINE CH
R134A / R404A / R507 / R22

Improved of air throw with CABERO ESS
Improved hygiene due to smooth powder coated surface as standard
Removable inspection panels
Drip tray can be folded down



QUALITY

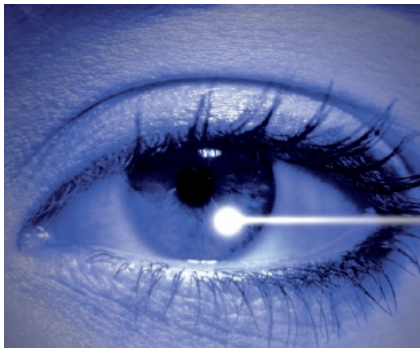

CABERO STANDS FOR COMPETENCE, INNOVATION UND PROSPERITY

CABERO is a synonym for competence, innovation and prosperity – and 25 years enthusiasm for the requirements of the market. Since 1980 CABERO has been developing and using most modern and efficient manufacturing technology and therefore setting benchmark. Specialisation and continuous investments in Research and Development (R+D), in optimised manufacturing methods and technologies guarantee the customer a constant and steadily quality as well as a high „added value“.



CABERO STANDS FOR QUALITY AND ENVIRONMENTAL AWARENESS

Through combination of proven and innovative design methods our „Research and Development“ centers have main focus on functionality and reliability. This not only applies to single unit but throughout the whole range with main emphasis to thermodynamic rules.

As a result we provide convincing equipment concept for installation, utilization, maintenance and safety in operation. This reflects in long term sustainability of the investment and excellent economy prospect.



LONG-TERM DURABILITY

CABERO equipment is supplied with powder coated surface protection on all covers. Environmentally friendly and food safe is applied to all cover parts prior to assembly. Importance of high safety protection is achieved through thoughtful design selecting prime materials and components, strict internal quality audits and random tests. This ensures and guarantees the customer long equipment durability and constant safety of goods and people.



COMMON HANDLING AND HYGIENE

Long lasting corrosion protection is essential for hygiene in cold rooms. Smooth and powder coated surfaces of CABERO equipment ensures easy compliance with current standards and codes.

Modern design with removable front and side covers, folding down drip tray and easy access to all parts of equipment reduces service costs and maintenance hours.



OPERATION

CABERO PROVIDES YOU OPTIMAL SOLUTIONS

A consequent market observation and analysis define our innovative product policy, driven by continuous further developments for the purpose of our customers. Thereby we focus on the maximum benefit for the environment and for our customers – true to our motto „we share your goals“.

Due to the two product lines, PROFESSIONAL LINE and ECONOMY LINE, CABERO is one of the few manufacturers, who offers for different operational areas two comprehensive, coordinated and qualitative high-grade air cooler product lines.



QUALITY, WHICH YOU REQUIRE

The operational areas are super markets, petrol stations, butcher`s shops, slaughter houses, groceries reloading points, cold storages and much more. The system provides here optimal protection of the goods - guaranteed through high safety of temperature. Sensitive reefer cargo like vegetables, meat, cheese or fish will be optimal matured and/or refined due to the ideal humidity level in the cold rooms. CABERO-air cooler are important components and guarantors for an efficient operation.



INSTALLATION AND OPERATION SECURITY

CABERO-air cooler can be fast and common mounted and maintained. In the stage of development we focus in particular on a easy handling of installation for the assembly operator. The important modules are easily accessible and guarantee our customers a safe operation without harmful foreign oils or foreign substances in the refrigeration plants.



CABERO STANDS FOR FLEXIBILITY, SERVICE AND ABILITY TO SUPPLY

CABERO defines the customer orientation not only in technical and commercial service and support, but rather in a flexible and specific assortment of products and with it linked availability of accessories and spare parts. This is supplemented through a sophisticated and adherence to just-in-time logistics of our own fleet management.



EXECUTION CH

HEAT EXCHANGER

especial designed copper tubes diameter 12 mm with high efficiency pure aluminium fins with a fin spacing 4 and 7 mm. Tube die 35x35 mm inline (PROFESSIONAL LINE).

On request: stainless steel tubes, several coated fins according costumer requirement. Schrader-valve at outlet.

CASING

Powder coated aluminium in RAL 9010, brackets for ceiling installation, drip tray with a folded down execution for easy cleaning and maintenance. Accessories and alternative: casing available in different materials such as double drip tray (insulated), electrical defrost in coil and drip tray, hot gas defrost, mounting box and cabling of the fan(s) and electrical defrost.

FANS

Axial fans designed for low noise level operation, with external or internal rotor system motors, wired on costumer requirement onto clamping device, motors 230V / 1 / 50 Hz, protection class IP44 according DIN 40050. Ambient temperature of operation: -30 °C up to +40° C. Protection grill according EN 294. For protection of fans, they are equipped with internal thermal contacts. The fans are suction versions. The data concerning the motors such as absorption and power may vary depending on environmental conditions and pressure drops. We reserve the right to use fans of different manufactors we have approved and tested. CABERO Efficiency Stream System (ESS) are available on request.

SOUND PRESSURE LEVEL

Using the enveloping surface method (open area = according EN 13487 at 1 m). As cooling rooms only have a very low absorbing capacity, we recommend that calculations are carried out with only slight reduction in the sound pressure level for other distance.





CAPACITY DATA

The catalogue capacities refer to Freon R404a – R507 a and are based on the air inlet temperature difference (difference between cooler air inlet temperature t_{li} and evaporation temperature t_0 $DT1 = t_{li} - t_0$).

These conditions are marked with DT1 and comply with ENV328 ref. SC2.

Evaporation temperature: $t_0 = -8 \text{ }^\circ\text{C}$

Subcooling temperature: $t_s = 5 \text{ }^\circ\text{C}$

Air inlet temperature: $t_{li} = 0 \text{ }^\circ\text{C}$

Relative humidity: RH = 85 %

OR

with $Dtm = 6 \text{ K}$

Evaporation temperature: $t_0 = -4 \text{ }^\circ\text{C}$

Superheating temperature: $t_s = 3 \text{ }^\circ\text{C}$

Air (room) temperature: $t_{di} = 2 \text{ }^\circ\text{C}$

Relative humidity: RH = 85 %

Refrigerant: R 404a

We recommend for an exact thermodynamic calculation in different conditions (for other refrigerants, air humidity or coated fins) to use our CABERO Calculation 2008.



DEFROST

Electrical coil and tray heating, wired onto clamping device according to VDE prescriptions. Water defrosting limit on $t_0 = -5 \text{ }^\circ\text{C}$

CH ... A (air defrost)

CH ... E (= electrical coil and tray heating)

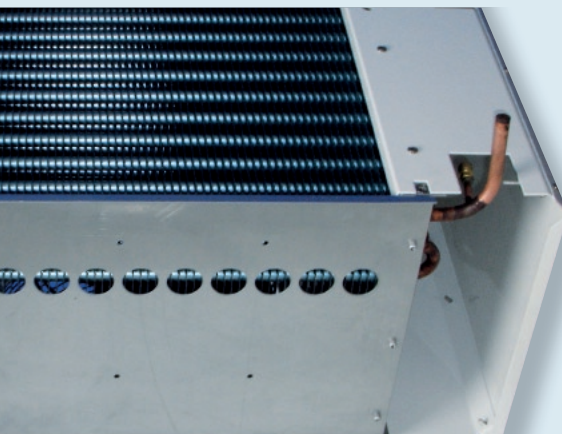

PRESSURE TESTS

Pressure test made with according to the PED 97 / 23 / EC and EN327: 2000 with 27,5 bar dry air overpressure and leak test.

Model CH	fin spacing	fin distance	coil code	number of fans	fan diameter in cm	generation key	nom. capacity		tube volume	exchange surface	airflow	Air throw	noise pressure level	connections		electrical defrosting				fan(s) 50 Hz				dimensions in mm						net weight		
							R 404a	SC2						SC3	inlet	outlet	Coil	Drip tray	Total	connection diagramm	capacity	current	current type	drain	L	B	H	E	E1		F	A
																									kW	kW	dm ³	m ²	m ³ /h		m	dB(A)
4.0 mm	4 B	1/30	.1	2.12	1.59	2.3	9.6	1580	6	59	12	12	900	450	1.40	A	85	0.38	230	G1	780	560	470	490		415	400	19				
	4 C	1/30	.1	2.59	1.82	3.1	12.8	1540	6	59	12	12	900	450	1.40	A	85	0.38	230	G1	780	560	470	490		415	400	22				
	4 B	1/35	.1	3.06	2.31	3.3	13.9	2480	7	63	12	12	1300	650	1.95	A	140	0.60	230	G1	980	560	470	690		415	400	26				
	4 C	1/35	.1	3.98	2.95	4.4	18.5	2390	7	63	12	16	1300	650	1.95	A	140	0.60	230	G1	980	560	470	690		415	400	28				
	4 D	1/35	.1	4.53	3.31	5.5	23.2	2240	6	63	12	19	2600	650	3.25	A	140	0.60	230	G1	980	560	470	690		415	400	30				
	4 E	1/35	.1	4.85	3.45	6.6	27.8	2110	6	63	12	19	2600	650	3.25	A	140	0.60	230	G1	980	560	470	690		415	400	32				
	4 B	2/30	.1	4.24	3.18	4.6	19.2	3160	7	62	12	19	1700	850	2.55	A	170	0.76	230	G1	1230	560	470	940		415	400	34				
	4 C	2/30	.1	5.17	3.65	6.2	25.6	3080	7	62	12	19	1700	850	2.55	A	170	0.76	230	G1	1230	560	470	940		415	400	38				
	4 B	2/35	.1	6.48	5.04	6.4	27.8	4980	9	65	12	19	2400	1200	3.60	A	280	1.20	230	G1	1630	560	470	1340		415	400	43				
	4 C	2/35	.1	7.97	6.10	8.5	37.0	4760	9	65	12	22	2400	1200	3.60	A	280	1.20	230	G1	1630	560	470	1340		415	400	47				
	4 D	2/35	.1	9.00	6.89	10.6	46.3	4430	8	65	16	22	4800	1200	6.00	B	280	1.20	230	G1	1630	560	470	1340		415	400	53				
	4 E	2/35	.1	9.89	7.21	12.8	55.6	4260	8	65	16	28	4800	1200	6.00	B	280	1.20	230	G1	1630	560	470	1340		415	400	58				
4 C	3/35	.1	11.91	9.08	12.6	55.6	6970	10	67	16	28	3500	1750	5.25	B	420	1.80	230	G1	2340	560	470	1990		415	400	69					
4 D	3/35	.1	13.85	10.29	15.7	69.5	6620	9	67	16	28	7000	1750	8.75	B	420	1.80	230	G1	2340	560	470	1990		415	400	75					
4 E	3/35	.1	14.94	10.79	18.9	83.3	6340	9	67	16	28	7000	1750	8.75	B	420	1.80	230	G1	2340	560	470	1990		415	400	82					
4 D	4/35	.1	18.47	13.76	20.8	92.6	8780	9	68	22	35	9200	2300	11.50	B	560	2.40	230	G1	2990	560	470	1340	1300	415	400	98					
4 E	4/35	.1	20.80	14.90	25.0	111.1	8490	9	68	22	35	9200	2300	11.50	B	560	2.40	230	G1	2990	560	470	1340	1300	415	400	107					

7 B	1/30	.1	1.48	1.17	2.3	5.9	1610	6	59	12	12	900	450	1.40	A	85	0.38	230	G1	780	560	470	490		415	400	18
7 C	1/30	.1	1.98	1.43	3.1	7.9	1560	6	59	12	12	900	450	1.40	A	85	0.38	230	G1	780	560	470	490		415	400	20
7 B	1/35	.1	2.35	1.73	3.3	8.5	2530	7	63	12	12	1300	650	1.95	A	140	0.60	230	G1	980	560	470	690		415	400	24
7 C	1/35	.1	2.81	2.17	4.4	11.4	2360	7	63	12	16	1300	650	1.95	A	140	0.60	230	G1	980	560	470	690		415	400	26
7 D	1/35	.1	3.45	2.55	5.5	14.2	2280	6	63	12	19	2600	650	3.25	A	140	0.60	230	G1	980	560	470	690		415	400	28
7 E	1/35	.1	4.05	2.87	6.6	17.1	2220	6	63	12	19	2600	650	3.25	A	140	0.60	230	G1	980	560	470	690		415	400	30
7 B	2/30	.1	2.98	2.34	4.6	11.8	3220	7	62	12	19	1700	850	2.55	A	170	0.76	230	G1	1230	560	470	940		415	400	32
7 C	2/30	.1	4.24	3.04	6.2	15.8	3120	6	62	12	19	1700	850	2.55	A	170	0.76	230	G1	1230	560	470	940		415	400	36
7 B	2/35	.1	4.70	3.64	6.4	17.1	5200	9	65	12	19	2400	1200	3.60	A	280	1.20	230	G1	1630	560	470	1340		415	400	41
7 C	2/35	.1	5.87	4.65	8.5	22.8	5050	9	65	12	22	2400	1200	3.60	A	280	1.20	230	G1	1630	560	470	1340		415	400	44
7 D	2/35	.1	7.32	5.48	10.6	28.4	4820	8	65	16	22	4800	1200	6.00	B	280	1.20	230	G1	1630	560	470	1340		415	400	48
7 E	2/35	.1	8.26	5.98	12.8	34.1	4510	8	65	16	28	4800	1200	6.00	B	280	1.20	230	G1	1630	560	470	1340		415	400	51
7 C	3/35	.1	9.25	6.92	12.6	34.1	7430	10	67	16	28	3500	1750	5.25	B	420	1.80	230	G1	2340	560	470	1990		415	400	62
7 D	3/35	.1	11.02	8.27	15.7	42.7	7220	9	67	16	28	7000	1750	8.75	B	420	1.80	230	G1	2340	560	470	1990		415	400	67
7 E	3/35	.1	12.59	9.16	18.9	51.2	6950	9	67	16	28	7000	1750	8.75	B	420	1.80	230	G1	2340	560	470	1990		415	400	73
7 D	4/35	.1	13.71	10.74	20.8	56.9	9230	9	68	22	35	9200	2300	11.50	B	560	2.40	230	G1	2990	560	470	1340	1300	415	400	87
7 E	4/35	.1	16.94	12.40	25.0	68.3	9610	9	68	22	35	9200	2300	11.50	B	560	2.40	230	G1	2990	560	470	1340	1300	415	400	94

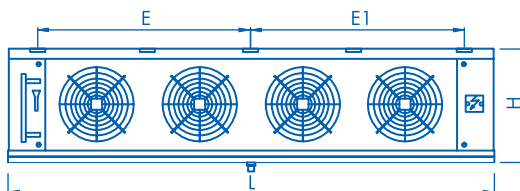
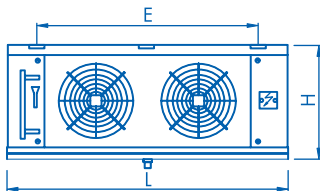
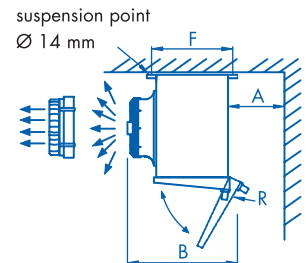
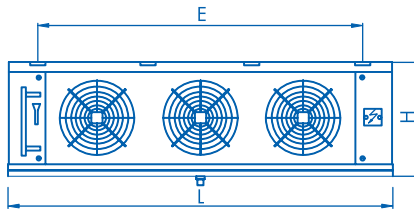
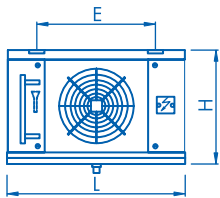



fin spacing	Model CH	nom. capacity R 404a	SC2	SC3	generation key	kW	kW	dm ³	m ²	m ³ /h	m	dB(A)	connections		electrical defrosting			fan(s) 50 Hz				dimensions in mm						net weight		
													inlet	outlet	Coil W	Drip tray W	Total kW	connection diagram	capacity W	current A	current type V	drain NW"	L	B	H	E	E1		F	A
4.0 mm	4 C 1/50 .1	11.46	8.31	11.9	51.3	7320	26	68	16	28	2975	1275	4.25	D	750	1.3	400	G1 1/4	1490	670	750	1120		510	550	73				
	4 D 1/50 .1	13.74	10.30	14.8	64.1	7110	25	68	16	28	4675	1275	5.95	D	750	1.3	400	G1 1/4	1490	670	750	1120		510	550	82				
	4 E 1/50 .1	15.19	10.99	17.8	75.9	6920	24	68	16	28	5100	1700	6.80	D	750	1.3	400	G1 1/4	1490	670	750	1120		510	550	90				
	4 G 1/50 .1	17.45	12.57	23.7	102.6	6510	22	68	22	35	5100	1700	6.80	D	750	1.3	400	G1 1/4	1490	740	750	1120		580	550	98				
	4 C 2/50 .1	23.22	17.00	23.2	102.6	14640	27	71	22	35	5775	2475	8.25	D	1500	2.6	400	G1 1/4	2570	670	750	1120	1080	510	550	134				
	4 D 2/50 .1	27.69	20.95	28.9	128.2	14220	26	71	22	42	9075	2475	11.55	D	1500	2.6	400	G1 1/4	2570	670	750	1120	1080	510	550	152				
	4 E 2/50 .1	30.72	22.42	34.7	153.9	13840	25	71	22	42	9900	3300	13.20	D	1500	2.6	400	G1 1/4	2570	670	750	1120	1080	510	550	168				
	4 G 2/50 .1	35.40	26.12	46.3	205.2	13020	23	71	22	42	9900	3300	13.20	D	1500	2.6	400	G1 1/4	2570	740	750	1120	1080	580	550	185				
	4 D 3/50 .1	41.49	30.77	43.1	192.3	21330	26	73	22	54	8575	3675	12.25	D	2250	3.9	400	G1 1/4	3650	670	750	1120	1080	510	550	214				
	4 E 3/50 .1	46.64	34.82	51.7	230.8	20760	25	73	28	54	14700	4900	19.60	E	2250	3.9	400	G1 1/4	3650	670	750	1120	1080	510	550	238				
	4 G 3/50 .1	51.68	36.80	68.9	307.7	19530	23	73	28	54	14700	4900	19.60	E	2250	3.9	400	G1 1/4	3650	740	750	1120	1080	580	550	273				
	4 D 4/50 .1	52.90	39.07	57.2	256.5	28440	26	73	22	54	11400	5700	17.10	D	3000	5.2	400	G1 1/4	4610	740	750	1120	1080	580	550	292				
4 E 4/50 .1	58.85	42.92	68.6	307.7	27680	25	73	28	54	14250	5700	19.95	E	3000	5.2	400	G1 1/4	4610	740	750	1120	1080	580	550	328					
4 G 4/50 .1	67.07	48.26	91.5	410.3	26040	23	73	28	64	17100	5700	22.80	E	3000	5.2	400	G1 1/4	4610	740	750	1120	1080	580	550	360					

6.8 mm	7 C 1/50 .1	8.79	6.59	11.9	31.5	7320	26	68	16	28	2975	1275	4.25	D	750	1.3	400	G1 1/4	1490	670	750	1120		510	550	68
	7 D 1/50 .1	10.24	7.75	14.8	39.4	7110	25	68	16	28	4675	1275	5.95	D	750	1.3	400	G1 1/4	1490	670	750	1120		510	550	75
	7 E 1/50 .1	12.13	8.81	17.8	47.3	6920	24	68	16	28	5100	1700	6.80	D	750	1.3	400	G1 1/4	1490	670	750	1120		510	550	82
	7 G 1/50 .1	14.37	10.42	23.7	63.0	6510	22	68	22	35	5100	1700	6.80	D	750	1.3	400	G1 1/4	1490	740	750	1120		580	550	89
	7 C 2/50 .1	17.72	13.42	23.2	63.0	14640	27	71	22	35	5775	2475	8.25	D	1500	2.6	400	G1 1/4	2570	670	750	1120	1080	510	550	124
	7 D 2/50 .1	20.59	15.66	28.9	78.8	14220	26	71	22	42	9075	2475	11.55	D	1500	2.6	400	G1 1/4	2570	670	750	1120	1080	510	550	137
	7 E 2/50 .1	24.45	17.89	34.7	94.5	13840	25	71	22	42	9900	3300	13.20	D	1500	2.6	400	G1 1/4	2570	670	750	1120	1080	510	550	151
	7 G 2/50 .1	28.93	21.10	46.3	126.1	13020	23	71	22	42	9900	3300	13.20	D	1500	2.6	400	G1 1/4	2570	740	750	1120	1080	580	550	165
	7 D 3/50 .1	31.40	23.75	43.1	118.2	21330	26	73	22	54	8575	3675	12.25	D	2250	3.9	400	G1 1/4	3650	670	750	1120	1080	510	550	196
	7 E 3/50 .1	36.03	27.04	51.7	141.8	20760	25	73	28	54	14700	4900	19.60	E	2250	3.9	400	G1 1/4	3650	670	750	1120	1080	510	550	216
	7 G 3/50 .1	40.67	29.32	68.9	189.1	19530	23	73	28	54	14700	4900	19.60	E	2250	3.9	400	G1 1/4	3650	740	750	1120	1080	580	550	243
	7 D 4/50 .1	39.01	29.00	57.2	157.6	28440	26	73	22	54	11400	5700	17.10	D	3000	5.2	400	G1 1/4	4610	740	750	1120	1080	580	550	272
7 E 4/50 .1	45.72	32.75	68.6	189.1	27680	25	73	28	54	14250	5700	19.95	E	3000	5.2	400	G1 1/4	4610	740	750	1120	1080	580	550	300	
7 G 4/50 .1	51.85	38.31	91.5	252.1	26040	23	73	28	64	17100	5700	22.80	E	3000	5.2	400	G1 1/4	4610	740	750	1120	1080	580	550	328	

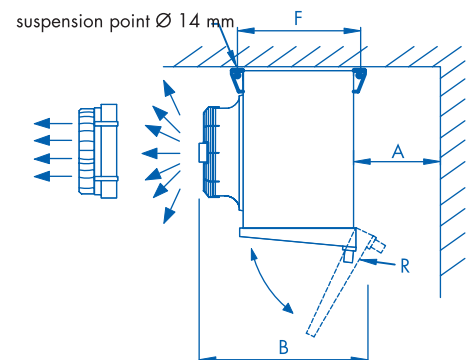
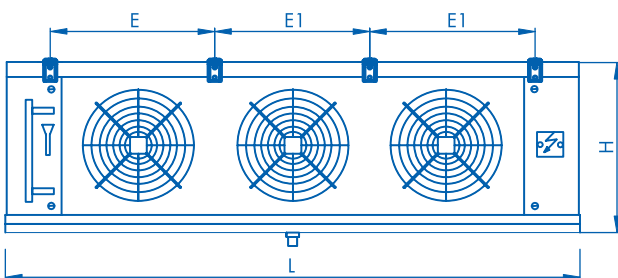
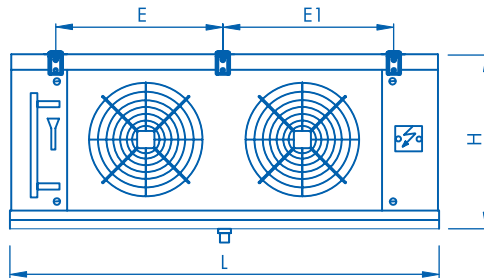
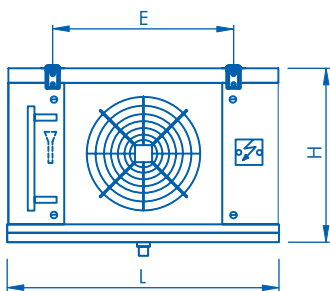



CABERO GUARD SYSTEM

– keeps your product fresh and saves you money

CABERO commercial units are designed with inline tube pattern similar to professional industrial units, yet with higher efficiency and minimised moisture removal from the cooled product. CABERO tube pattern keeps uniform temperature level over the fins and provides more fin surface in comparison with staggered tube patterns used in most of the commercial cooler which are available today. Hence moisture is not removed from product on the large scale. We end up with less weight loss and minimised shrivel. Since moisture is not removed on a large scale from the cooled product we end up with less weight loss and minimised shrivel effect. In real terms, this means more money in the producers pocket and the product is kept fresh for a longer period of time.



CABERO ENERGY SAVING

– the best contribution towards our environment

CABERO inline tube pattern on commercial coolers will also save energy needed to cool the product, when compared with staggered tube pattern coolers. CABERO commercial coolers have lower ice formation on its coils and therefore require less frequent defrosting, which is achieved with lower moisture removal from the cooling rooms. Less defrosting means less power consumption, to keep the unit free of ice and operating at optimum level. Less defrosting also means less heat input into the room, which would again need to be removed from the room.

CABERO inline tube pattern has lower air resistance through the coil which reduces fan power consumption, improves fan efficiency and air distribution as well. Combining above mentioned points results in increased overall system efficiency and reduction in compressor operation and power input. This technology not only reduces operating cost and power consumption but has a large contribution towards our environment.



CABERO WARRANTY TIME

– give you the reliability to use a professional product

With highly educated team at CABERO Group we continuously search for technology and products beneficial to our customers and our environment. All products are designed and produced under strict quality management and ISO 9002.

As our team is dedicated to provide our customers with highly reliable product CABERO only deals with suppliers that obey our quality system, provide high quality and innovative product manufactured to world standards. Therefore we are glad to provide you with 2 years warranty.



CABERO PERFORMANCE WARRANTY

– professional and reliable technique

CABERO units are developed and designed for performance with highest German quality standard. Our highly skilled engineers continuously perform operation and capacity tests in our laboratories to ensure customers satisfaction. However through numerous installations our customers happily report back with satisfying results which is the best test we can have.

CABERO products are also tested from official accredit laboratories and approved for quality and performance to provide our customers piece of mind. The commercial coolers have been tested and designed according ENV328.



SPECIAL FEATURES AND STANDARDS

COMMERCIAL COOLERS:

STANDARDS:

- Unit casing are manufactured from high grade aluminium and powder coated white – for greater corrosion protection and hygiene
- Drip tray double side painted for easy cleaning
- Drip tray executed with triple folded edges for easy cleaning
- Drip tray thermally decoupled and detachable from the heat exchanger casing
- Improved and optimum condensate drainage
- Less dehumidification (moisture) and ice formation according professional inline pattern
- Separate fan compartments
- Deeper fan suction compartment
 - improved and optimum distribution of air with constant air speed over the heat exchanger resulting in a reduction of energy consumption.
- Junction box and wiring with cable glands
- Air by pass sheet with unique drainage system
- Units with modern and creative design for easier cleaning and minimum dirt accumulation
- Side cover sheet prepared for easy maintenance
- High efficiency fans adapted to the technical requirements
- Low maintenance and long service life
- Robust design
- Reduced defrosting power according new heater generation
- Adapted for normal and deep-freeze refrigeration-fin spacing 4.0 mm or 7.0 mm
- Cooler totally flash mounted to the ceiling – no gap
- all terminal boxes IP54

WIDE RANGE OF ACCESSORIES:

- Blue fins (anti corrosion)
- Increment of air throw property trough CABERO ESS
- Double (insulated) drip tray
- Mounted expansion valve
- etc.

Correction factors acc. to Eurovent

Q_N = evaporator nominal catalogue capacity

Q_0 = evaporator capacity

$$Q_0 = Q_N \times F_1 \times F_2$$

F_1 correction factor for refrigerant

	refrigerant	R404A	R507	R134a	R22
F_1	$t_0 = -8 \text{ }^\circ\text{C}$	1.0	1.0	0.91	0.95
	$t_0 = -25 \text{ }^\circ\text{C}$	1.0	1.0	0.85	0.95

F_2 correction factor for fin material

	F_2 material
1.00	aluminium
0.97	coated aluminium
1.03	copper

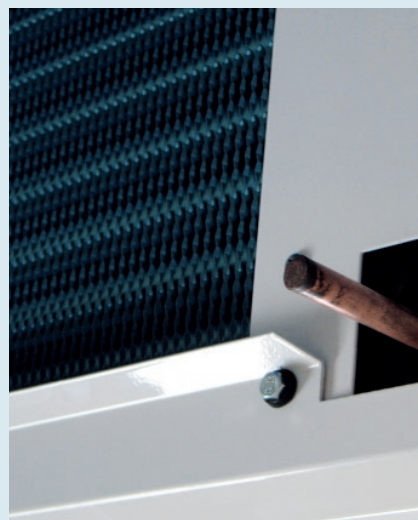

WARRANTY

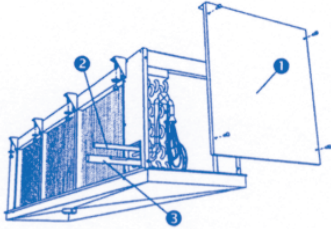

Figure A

A – CABERO warrants that the products shall be free from defects in material and workmanship for the period of 12 months from the date of the delivery. Therefore, should CABERO within the warranty period, acknowledge and recognize in writing the existence of the defects in the products and said defects be materially grounded, CABERO shall, at its discretion, repair the defective products at no costs for the client or replace them by delivering the substitutive products (Ex works – Incoterms CABERO).

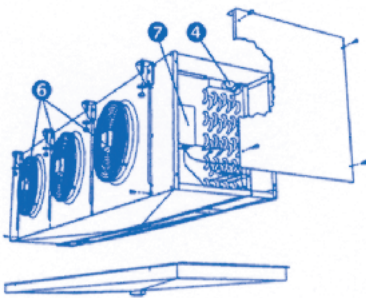

Figure B

B – Subject to loss of the warranty, notice of any defect shall be given by the client in writing with return receipt registered letter within, and not later than, 10 (ten) days from the date of receipt of the products at the client’s premises or in the different delivery place, previously indicated by the latter. It is hereby understood that the burden of the proof of the date of the discovery shall be borne by the client.

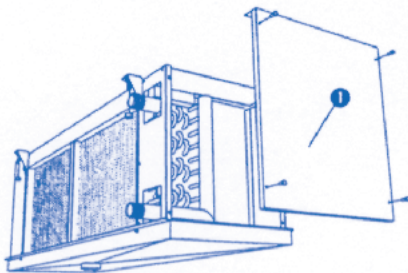

Figure C

C – CABERO also warrants that the products are manufactured in compliance with the European Laws and /or Regulations in force on the date of the confirmation by CABERO of the relevant client’s order. Unless otherwise expressly agreed in writings by the parties. Client shall bear any other additional expenses related to the operations of repairing or replacing of the defective products.

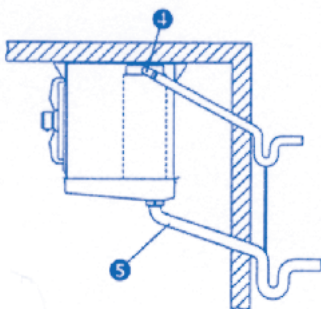

Figure D

D – This warranty shall not apply should the defects of the products be caused by:

- natural wear and tear
- unauthorized repairs, interventions or modifications
- unsuited use or application
- thermal overexposure, also when occasional
- electrical or mechanical overstress
- failure of respecting the functional and environmental parameters suggested by CABERO for the correct use and exploitation of the products
- installation of the products not in compliance with the technical specifications provided by CABERO
- any other cause due the client’s negligence.



- E** – This warranty shall also not apply in case of:
- non compliance of the products with European Law and/or Regulations entered in force after the date of transmission of the order confirmation by CABERO.
 - non compliance of the products with Laws and/or Regulations in force in the place where the products are installed and/or assembled by the client and/or in the place of their final use, should the client not expressly require the conformity of the products to said Laws and Regulations and not duly inform CABERO of their content before the date of transmission of the latter's order confirmation.

This limitation of the warranty is also applicable with reference to peculiar Laws and Regulations valid and binding in States of the European Union independently of the European Laws and Regulations.

- F** – The client shall not sell or market products not in compliance with the Laws and Regulations mentioned under letter E above. In the negative, the client shall keep CABERO harmless of any damage or loss suffered by the latter, due to any third party's and/or authority's claim raised as a consequence of the manufacture by CABERO of products not in compliance with the above mentioned Laws and Regulations.

INSTALLATION

- Mount suitably sized tie rods on the ceiling, cut the straps and remove the tray from the box. Lift the unit using a standard pallet and fit the appliance to the ceiling with nuts and washers.
- Screw on the condensate tray.
- Remove the panel covering the couplings 1 and connect the supply lines complying with the coupling sections.

TYP CH

- Mount the expansion valve on the supply line 2 and position the bulb correctly on the suction line 3.

TYP CH

- Connect the supply line to the defrost sprinkler 4 (if provided) according to the diagram in figure D.
- Connect drain pipe 5 to the condensate tray.
- Wire the power lines from the switch board to the motor distribution boxes 6 and separately to the electric defrost distribution box 7 if provided, following the wiring diagrams found inside the actual boxes.

WARNING

Do not carry out any wiring connections while the power is connected. All electrical and refrigerant connections must be carried out by a qualified personnel.
The coil has approx. 1 bar overpressure of dry air, release with care.



CABERO Version 08 / 2007

CABERO HEAT EXCHANGER

CABERO Wärmetauscher GmbH & Co. KG
Jesenwanger Strasse 50
82284 Grafrath, Germany
Phone: +49 8144 9396-0
Fax: +49 8144 9396-20
E-mail: info@cabero.de | www.cabero.de

